

Photo Printing Solutions



CP-M1E

Photo Printer



The new high capacity photo printer

The CP-M1E Mitsubishi Electric Photo Printer delivers exceptional print quality, printing volume up to 750 prints 10x15cm (4x6") and very easy media replacement in a reduced footprint. The result is a very powerful printer model, which saves time and operational costs.

Main features

- // User-Friendly media replacement
- // Compact design
- // High capacity printing
- // Exceptional printing quality
- // Rewind function
- // Dust resistant design



Rewind function

New Rewind function optimizes the 10x15 cm /4x6" prints. When the last half part of the ribbon patch is not used in the last order it can be capable for next printing order of 10x15 (4x6"). Rewind feature does not work in Matte Finish.

High capacity printing

With up to 750 prints capacity (10x15 cm) in a very reduced size, it's a very complete solution perfect for high capacity demand and less media exchange operations, making it a cost saving model and perfect for photo booth use.

Exceptional printing quality

No compromise on print details in bright or dark prints. Designed with Mitsubishi Electric's proprietary print-head control engine & image processing, algorithms enable printing of high quality photos, delivering a Superior color depth and Extreme detailed output.

Compact design

With a very reduced footprint 0,105m², and a weight of 14kgs, the CP-M1E fits almost anywhere. Also its inedit exchange media system makes it very easy to operate.

Dust resistant design

The CP-M1E comes with a new Dust-resistant design, that minimizes operational and printing issues caused when installed in dusty environment. That's perfect for photobooth. Air flow paths of power circuitry and the thermal head in the print engine are discrete and separate as well as designed with positive pressure air-flow that forces out dusts and small particle while providing efficient cooling to the print engine.

User-Friendly Media Replacement

Easy and Quick Media replacement system that minimizes customer's waiting time. It allows immediate loading when taken out of the box, reducing the economic loss caused by dropping media and the invasion of dust during media exchange.

Features

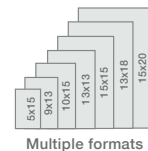
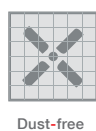
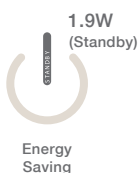



User-Friendly Media Replacement

The new media exchange method is user-friendly design which makes media reloads quick and easy. It allows immediate loading when taken out of the box. Media replacement is so simple as 3 easy steps accessible from the front of the printer.

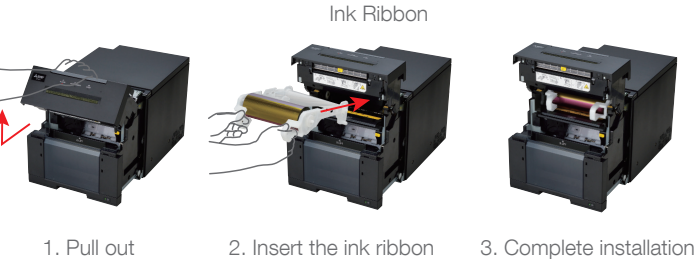

- Simple one-hand pull out operation.
- Ink-Roll comes pre-assembled in built-in cartridge out of the box, Insert the ink-ribbon.
- Set the ink-ribbon firmly in place to complete installation

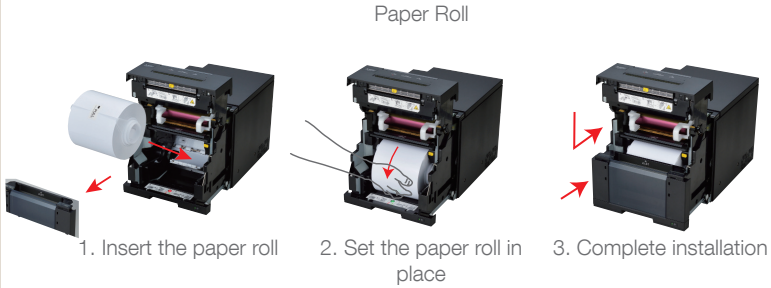

- Paper roll comes pre-assembled with built-in flanges. Take out the dust bin and insert the paper roll.
- Simply remove the sealing tape from the paper roll and roll the paper into its proper position. When it is set correctly, green LED indicator will light up.
- Replace the dust bin into its proper position and close the front printer access door.

High Capacity & Compact Design

Maximize space and maximize capacity with this compact design. Compact design with special cable management channel. Ideal for integration into photo booths.

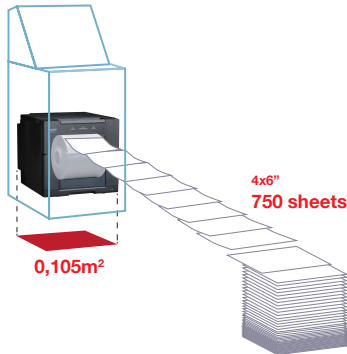

Compact yet high volume of 750 prints (4x6") per roll. Reduce need for media change frequency, saving time and operations cost.

Support Multiple Sizes

Various print sizes are customizable by using our custom SDK.



Exceptional print quality. No compromise on print details in bright or dark prints

Designed with Mitsubishi's proprietary print-head control engine & image processing algorithms enable printing of high quality photos.

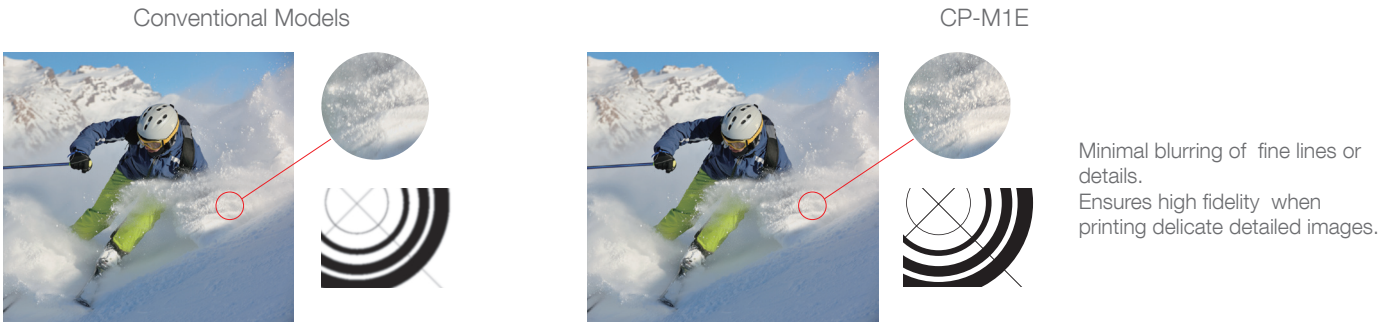

Dust-resistant design

Minimize operational and printing issues caused even when installed in dusty environment.

Air flow paths of power circuitry and the thermal head in the print engine are discrete and separate and designed with positive pressure air-flow that forces out dusts and small particle while providing efficient cooling to the print engine.

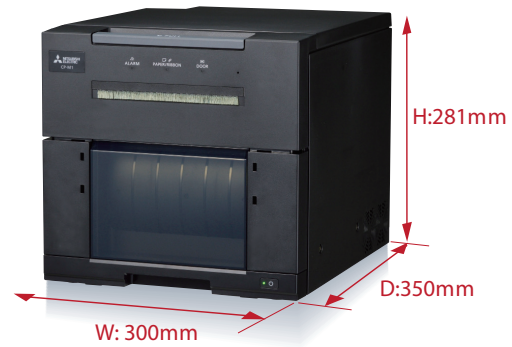
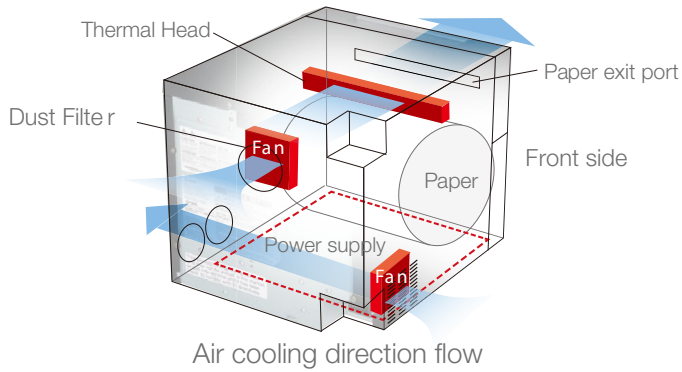

Technical specifications

System compatibility	Windows/ Mac		
Printing method:	Dye sublimation thermal transfer line print		
Print options	Single-sided printing		
Memory capacity	128MB		
Print capacity	Up to 750 prints 10x15 cm (4x6")		
Weight	14kg (30.0lb)		
Foot print	0.105 square meters		
Print speed (10x15cm - 4x6")	12s		
Resolution	300DPI		
Dimensions W/D/H	300 / 350 / 281 mm.		
Power consumption	4.0A (100-240VAC, 50/60Hz) 1.9W standby at 230V 50Hz		
Accessories	Paper Strip bin, Printer tray, Quick set up guide, Safety guide, Power cord (EUR)		
Printer Media References	Ref.	Print size (cm)	Print size (inch)
	CK-M57S	9x13 / 13x13 / 13x18	3.5x5" / 5x5" / 5x7"
	CK-M68S	5x15 / 10x15 / 15x15 / 15x20	2x6" / 4x6" / 6x6" / 6x8"
	CK-M46S	5x15 / 10x15	2x6" / 4x6"

Specifications are subject to change without notice